



UMB8.5

8 1/2' DIAMETER UMBRELLA
WITH CRANK LIFT

WEBCOAT PRODUCTS
P.O. BOX 3160
McALESTER, OKLAHOMA 74501
1-800-505-5101
FAX: (918)426-5924
E-MAIL: WEBCOAT@WEBCOAT.COM

Please take the time to locate and identify each part. Assemble the units on a smooth flat surface. It is also helpful to lay the tops and seats on cardboard or a drop cloth to prevent scratching of the surface during assembly. All parts have been pre-cut and pre-drilled for ease of assembly. All holes are slotted to allow for easy assembly and for final levelling of tops and seats to frames. Fully assemble all parts without totally tightening nuts and bolts. After all assembled go back and retighten nuts to bolts. DO NOT OVER TIGHTEN NUTS TO BOLTS. Over tightened nuts can crack the plastisol coating. All the necessary quantities of parts required are listed in this assembly instructions.

DO NOT BEGIN ASSEMBLY UNTIL YOU HAVE READ THESE INSTRUCTIONS AND ARE FAMILIAR WITH THE PARTS.



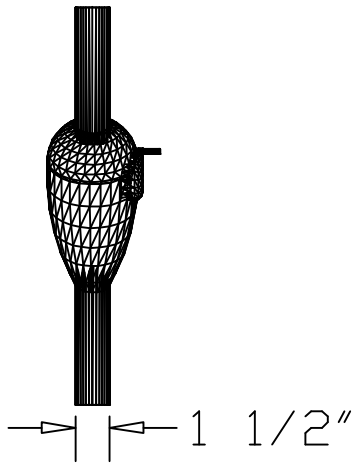

CHROME PLATED HANDLE
WITH ROTATING KNOB
FOR EASY CRANKING

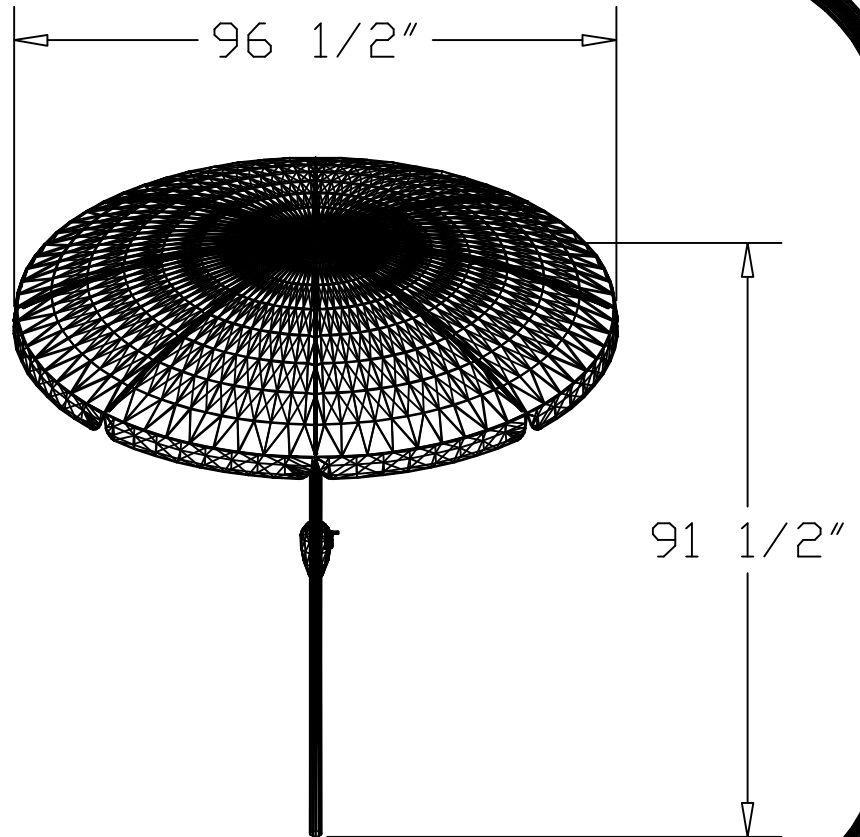

SPECIFICATIONS

8 1/2' DIAMETER CONVENTIONAL STYLED UMBRELLA.
PERFECT FOR ROUND OR SQUARE TABLES.

BRIGHT ANODIZED EXTRUDED ALUMINUM TUBING. ZINC PLATED STEEL
SPRING WIRE RIBS. ABS HOUSING.

AVAILABLE IN VINYL SOLID COLORS OR ALTERNATING PANELS.
CHOOSE FROM RED - BROWN - MARINER BLUE - GREEN - BLACK -
WHITE - YELLOW - TEAL - CLAY - ORANGE AND GRAY

POLE FINISHES IN POLISHED ANODIZED FOR PERMANENT PROTECTION
AGAINST CORROSION.

WEIGHT FOR THE UMB8.5 IS 20 lbs.

MAINTENANCE

To maintain luster it is recommended to wash, rinse, and dry the units after prolonged use. Check for loose bolts and nuts and tighten as needed. Contact the factory for genuine Webcoat part replacements if needed.